

QST SNK EF C

QUEST Tap Range Quest Easyfit Mono Sink Mixer Chrome



Features:

- Long life and easy to use 1/4 turn ceramic disc valves
- Metal fixing nut for added durability
- Easyfit base included
- Flexible tails included

Product Certifications:



WRAS Certificate No: 2012901
WRAS Expiry Date: 31/12/2025



For more products, visit our website:
<http://www.bristan.com>



Specification

Product Type:	Kitchen Taps
Main Construction Material:	Brass
Mount Type:	Deck Mounted
Handle Type:	Lever Handles
Connection Inlet:	1/2" BSP Female Flexible Tails
Connection Outlet:	M22 Flow Straightener
Number of Tap Holes:	1
Valve/Cartridge Type:	1/2" Ceramic Disc Valve
Plumbing System Requirements:	Suitable for all plumbing systems
Minimum Dynamic Pressure (bar):	0.4 bar
Maximum Dynamic Pressure (bar):	5.0 bar
Maximum Hot Water Temperature °C:	65°C
Maximum Static Pressure (bar):	10 bar
Flow Type:	Single Flow
Isolation Included:	Yes

Dimensions (measurements in mm)

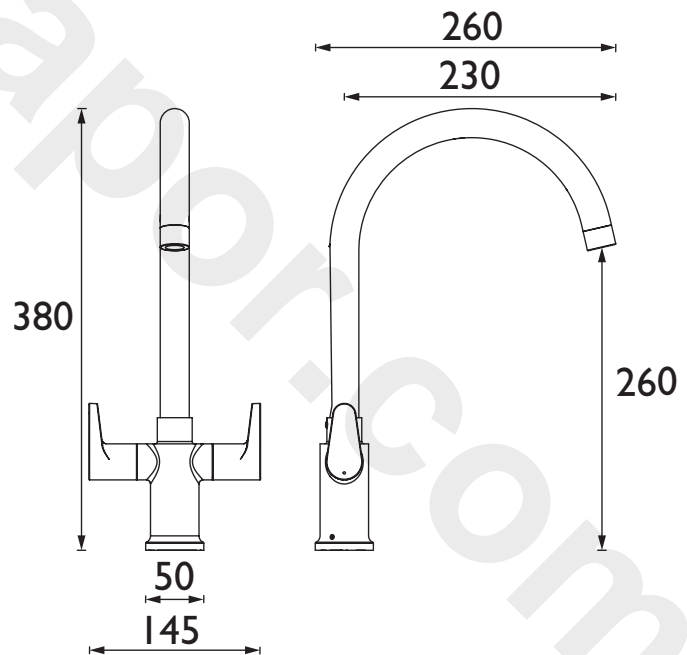

Flow Rates (l/min)

System Pressure (bar)	0.4	0.5	1	2	3	5
QST SNK EF C (mixed)	14.5	16.2	22.9	32.4	39.7	51.3

TECHNICAL DATA SHEET



BRISTAN

D6